

Fieldpiece[®]

Refrigerant Recovery Machine

OPERATOR'S MANUAL

Model MR45

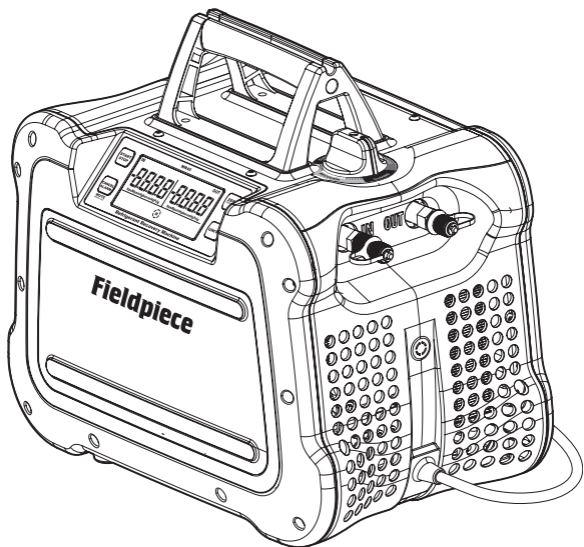

Contents

Important Notice 4

What's Included. 4

Warnings 4

Specifications 5

Description 6
Features

Certifications 8
UL Verified Performance Data

Safety Information. 9
First Aid for Refrigerant Exposure
General
Environmental
Personal Protection
MR45 Protection
Setup
Operational
Grounding Instructions

Tech Tips 12
General
Setup
Operational

Controls 14
Display and Buttons
Status Icons and Messages
Port Routing Control
MR45 Refrigerant Flow
Dynamic Pressure Measurement

Functions 22
Self Test
Self Purge
Purging a Recovery Cylinder
Direct Liquid/Vapor Recovery
Push/Pull Recovery

Troubleshooting 28
Status Messages
Other Symptoms

Maintenance. 30
General
Mesh Screen Filter

Limited Warranty 32
Obtaining Service

Important Notice

This is not a consumer machine. Only qualified personnel trained in the recovery or pumping of refrigerant may operate this machine.

Read and understand this operator's manual in its entirety before using MR45 to prevent injury or damage to you or equipment.

What's Included

- MR45 Refrigerant Recovery Machine
- 10 Extra Mesh Screens for Input Port
- 3 Extra O-ring for Input Port
- Operator's Manual
- 1 Year Warranty

WARNINGS

Ensure proper equipment grounding, electrical shock risk.
Do not expose to rain, electrical shock risk. Store indoors.
Do not use to pump hydrocarbons, explosion risk.
Do not use to pump flammable media, explosion risk.
Inhalation of high concentrations of refrigerant vapor can block oxygen to the brain causing injury or death.
Refrigerant liquid can cause frostbite.

Specifications

Display: 2 x 10000 count LCD with status messages

Backlight: Blue color

Measurement rate: 3.3 times per second, nominal

Input Port Pressure Sensor Range:

-30" Hg to 600 psig (-76 cmHg to 4100 kPa)

Output Port Pressure Sensor Range:

-30" Hg to 600 psig (-76 cmHg to 4100 kPa)

High Pressure Cutoff: 558 psig (3850 kPa), nominal

Resolution and Units: 1 psig (1" Hg), 0.05 bar (2 cmHg), 0.01 Mpa (2 cmHg), 5 Kpa (2 cmHg)

Pressure Sensor Accuracy:

± 0.5" Hg, ± 1.3 cmHg (Vacuum)

± (0.6% of reading +2 psig), ± (0.6% of reading +14 kPa)

Final Recovery Vacuum: 14.9" Hg, 38 cmHg

Compressor: Twin cylinder reciprocating (oil-less)

DC Motor: 1 HP (variable smart speed)

Power Source: 120 VAC @ 60 Hz 1 phase

Nominal Current Draw: 12.0 AAC

Valve: Single dual-route ball valve

Input Port Filtration: 9 mm mesh screen, stainless

Dimensions: 14.8 inch x 9.8 inch x 13.5 inch

376 mm x 250 mm x 344 mm

Weight: 22 lbs, (10kg)

Operating Environment: 32°F to 104°F (0°C to 40°C)

Storage Environment: -4°F to 140°F (-20°C to 60°C)

Approved Refrigerants: R12, R134A, R22, R401A (MP39), R401B, R401C, R402A, R402B, R404A, R406A, R407A, R407B, R407C, R407D, R408A, R409A, R410A, R411A, R411B, R412A, R500, R502, R507, R509.

US Patent: www.fieldpiece.com/patents

Description

The MR45 is the first variable speed DC motor recovery machine with a digital display. Pump refrigerant easier and quieter than ever before. Connect your hoses without navigating around dark tight spaces or picking the pump off the ground. View status messages and pressures directly on the big bright display.

Carry the machine to and from the job site easily and well protected from environmental hazards. Turn the single rubberized control valve to route refrigerant through MR45, and use the self-purge function to pump the last traces into the recovery cylinder instead of being left in the machine or released into the environment.

Features

- **Lightweight (22 lbs)**
- **Smooth and Fast Operation (1 HP DC Motor)**
- **Digital Display with Status Messages**
- **Reliable Rubberized Construction**
- **Easy to Access Port Design**
- **Hex Nut Secures Input Port During Hose Removal**
- **Power Cord Storage**
- **Ceramic Cylinders**
- **Self Purge**
- **Operation Down to 95VAC**
- **UL Verified to Section 608 of EPA Clean Air Act**
- **UL Verified to AHRI Standard 740**

Certifications



WEEE (Do not dispose through typical waste streams.)

IN ACCORDANCE WITH SECTION 608 OF THE CLEAN AIR ACT: THIS EQUIPMENT HAS BEEN CERTIFIED BY UNDERWRITERS LABORATORIES INC. TO MEET EPA'S MINIMUM REQUIREMENTS FOR RECOVERY EQUIPMENT INTENDED FOR USE WITH CATEGORY III, IV, AND V REFRIGERANTS OUTLINED IN AHRI 740-98, TABLE 4. <SA44565>

UL Verified Performance Data

Refrigerant	R22	R134A	R407C	R410A
Push/Pull Recovery (kg/min)	4.6	5.4	5.2	7.2
Liquid Recovery (kg/min)	4.7	2.9	5.1	5.6
Vapor Recovery (kg/min)	0.28	0.28	0.33	0.33
Final Recovery Vacuum (kPa)	50.8	50.8	50.8	50.8
Residual Trapped Refrigerant (kg)	0.005	0.008	0.004	0.005
High Temp (104°F) Vapor Recovery (kg/min)	0.40	-	-	-

Safety Information

First Aid for Refrigerant Exposure

Inhaled: Move to fresh air immediately.
Eye: Immediately flush eye with water. Seek medical attention.
Skin: Immediately flush skin with water. Seek medical attention.

General

1. This is not a consumer machine. Only qualified personnel trained in the recovery or pumping of refrigerant may operate this machine.
2. Read and understand this operator's manual in its entirety before using MR45 to prevent injury or damage to you or equipment.

Environmental

1. Use only within operating environment specification.
2. Ensure fan opening is clear of debris.
3. Explosion and fire risks:
Do not use near sewer lines.
Do not use in poorly ventilated enclosed areas.
Do not use near gasoline, acetylene, or other flammable gases.
Do not use to pump hydrocarbons.
Do not use near flames or sparks.
Assume all components are pressurized.

Personal Protection

1. Frostbite danger. Be careful using hoses.
2. Use personal protective equipment:
Wear safety goggles.
Wear earplugs if using for long durations.
Wear protective gloves.

MR45 Protection

1. Use only on approved list of refrigerants (page 8).
2. Do not use with hydrocarbons.
3. Ensure mesh screen filter is installed and clean (page 30).

Setup

1. Repair any damaged parts before using.
2. Disconnect power and allow fan to stop before opening or servicing MR45.
3. Perform self test periodically (page 22).
4. Ensure power cord is not damaged.
5. Ensure all equipment is grounded.
6. Extension cord options:
14 AWG or thicker, up to 50 feet (15 m)
DO NOT USE 18 AWG!
NOTICE: Risk of Property Damage. The use of an undersized extension cord will cause voltage to drop resulting in power loss to the motor and overheating.
7. Ensure extension cord is grounded, 3 conductor, and is not damaged.

Operational

1. Use correct refrigerant hoses with ball valve shutoffs.
2. Keep track of the current amount of refrigerant in the cylinder. Refrigerant scales are a good way to do this.
3. Overfilling a cylinder past 80% can cause an explosion and violates DOT laws.
4. Close cylinder off from refrigerant if it reaches 80% of its capacity.
5. Use only DOT CFR 49 or UL-approved refrigerant cylinders for the refrigerant being recovered.
6. Use recommended accessories.
7. Use a small filter drier on the input port and change it often to protect machine from contaminated refrigerants.

8. Monitor pressures and temperatures.
9. Self purge MR45 after each use. No refrigerant should remain in the machine.

Grounding Instructions

This product must be grounded. In the event of an electrical short circuit, grounding reduces the risk of electric shock by providing an escape wire for the electric current. This product is equipped with a cord having a grounding wire with an appropriate grounding plug. The plug must be plugged into an outlet that is properly installed and grounded in accordance with all local codes and ordinances.

WARNING – Improper installation of the grounding plug is able to result in a risk of electric shock. When repair or replacement of the cord or plug is required, do not connect the grounding wire to either flat blade terminal. The wire with insulation having an outer surface that is green with or without yellow stripes is the grounding wire.

Check with a qualified electrician or serviceman when the grounding instructions are not completely understood, or when in doubt as to whether the product is properly grounded. Do not modify the plug provided; if it does not fit the outlet, have the proper outlet installed by a qualified electrician.

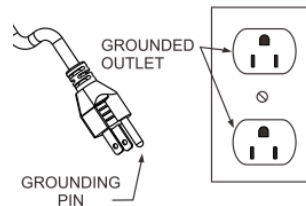

Safety First!

For use only by qualified and certified technicians in the safe use, handling, and transporting of refrigerants. Please refer to flammable refrigerant safety guides, regional codes and legislation for more information.

WARNINGS – failure to heed these hazards and actions can result in serious injury or death

1. Always use a grounded outlet
2. Always wear Proper Protective Equipment (PPE), which includes gloves and safety glasses
3. Know proper safety and handling requirements of the refrigerant in the Safety Data Sheet (SDS)
4. Avoid breathing refrigerant and oil vapors
5. Handle hoses and equipment carefully as refrigerant is under high pressure and can cause frost bite
6. Do not operate in or near explosive atmospheres
7. Perform leak detection in accordance with recommended practice to verify working environment is free from leaking refrigerant as it can be toxic and or flammable
8. Only work in well-ventilated areas (minimum of 4 air exchanges per hour)
9. Ensure power and extension cords are in good working condition to prevent shock and spark hazards

Additional safety instructions for recovering A2L refrigerants (e.g. R-32, R-1234yf, R-1234ze):

1. Adhere to local occupational safety codes and possess detailed knowledge and skills when handling mildly flammable refrigerants
2. Have emergency, evacuation, and fire protection plans

3. Designate and monitor a Temporary Flammable Zone with a 3-meter perimeter
4. Identify and disable all possible ignition sources within this Zone
5. Monitor air with a flammable refrigerant leak detector within this Zone
6. Use a ventilation fan to maintain 5 air exchanges per hour within this Zone
7. Make power connection of the recovery machine and other equipment outside of the Temporary Hazard Zone
8. Bond the recovery machine outlet port to the recovery tank's unpainted fitting with a grounding strap to dissipate static electricity buildup during recovery process
9. Ensure area around machine is free of debris that could enter air vents and fan and cause accidental sparking
10. Always remain in attendance and observant when the machine is running
11. Do not mix flammable refrigerants with air
12. Use an evacuated DOT recovery tank
13. If system has a suspected leak, stop recovery at 0 psig/bar to prevent air from entering the recovery tank
14. After recovery, purge system with 100% nitrogen before opening system for repair

CAUTIONS – failure to heed these conditions can cause equipment damage.

1. Ensure that recovery machine, hoses, tank and other equipment are in good working condition
2. Avoid overfilling recovery tanks by following refrigerant manufacturer's filling instructions and using a weight scale
3. Avoid cross contamination by not mixing refrigerants

Tech Tips

General

1. Store in the self purge or recover position. Do not store in the CLOSED position as trapped air and refrigerant can expand and damage components.
2. For extended storage, purge with nitrogen, set to RECOVER, and screw non-sealing caps onto the ports.
3. Recovery machines are not vacuum pumps and should not be used for deep evacuations.
4. Do not run the machine without the mesh screen filter (page 30). Doing so will void the warranty and damage the machine.
5. Understand the refrigerant safety data sheet (SDS).

Setup

1. Know the refrigerant of the system and make sure your recovery cylinder matches that type.
2. Hoses:
Short as possible (3/8" hose with 1/4" fitting).
Core depressors removed.
Ball valve shutoffs instead of low loss fittings.
Replace if worn.
3. Manifold gauges are not necessary for recovery but can make it more convenient and increase speed by having 2 system hook ups.
4. Use a Schrader valve core removal tool to temporarily remove valve cores from service valves.
5. Use the push-pull method if recovering over 30 lbs (14kg).
6. Evacuate your empty recovery cylinders to 29.6" Hg (75 cmHg) before use.

7. Know how much refrigerant you expect to recover before starting.
8. Ensure there's enough room in the recovery cylinder to not exceed 80% filled during the job, or monitor and have a second cylinder ready.
9. Always purge hoses before recovery. If cylinder is too hot, use an ice bath to reduce the temperature and pressure of the cylinder.
10. If cylinder pressure is higher than expected, you can purge non-condensables into another cylinder (page 23).

Operational

1. Recover as much liquid as possible before recovering vapor.
2. Recovery is faster when the recovery cylinder is cooler.
3. You can use a heat gun to warm refrigerant lines to boil trapped refrigerant.
4. Recover from both suction and liquid lines at the same time for faster vapor recovery.

Controls

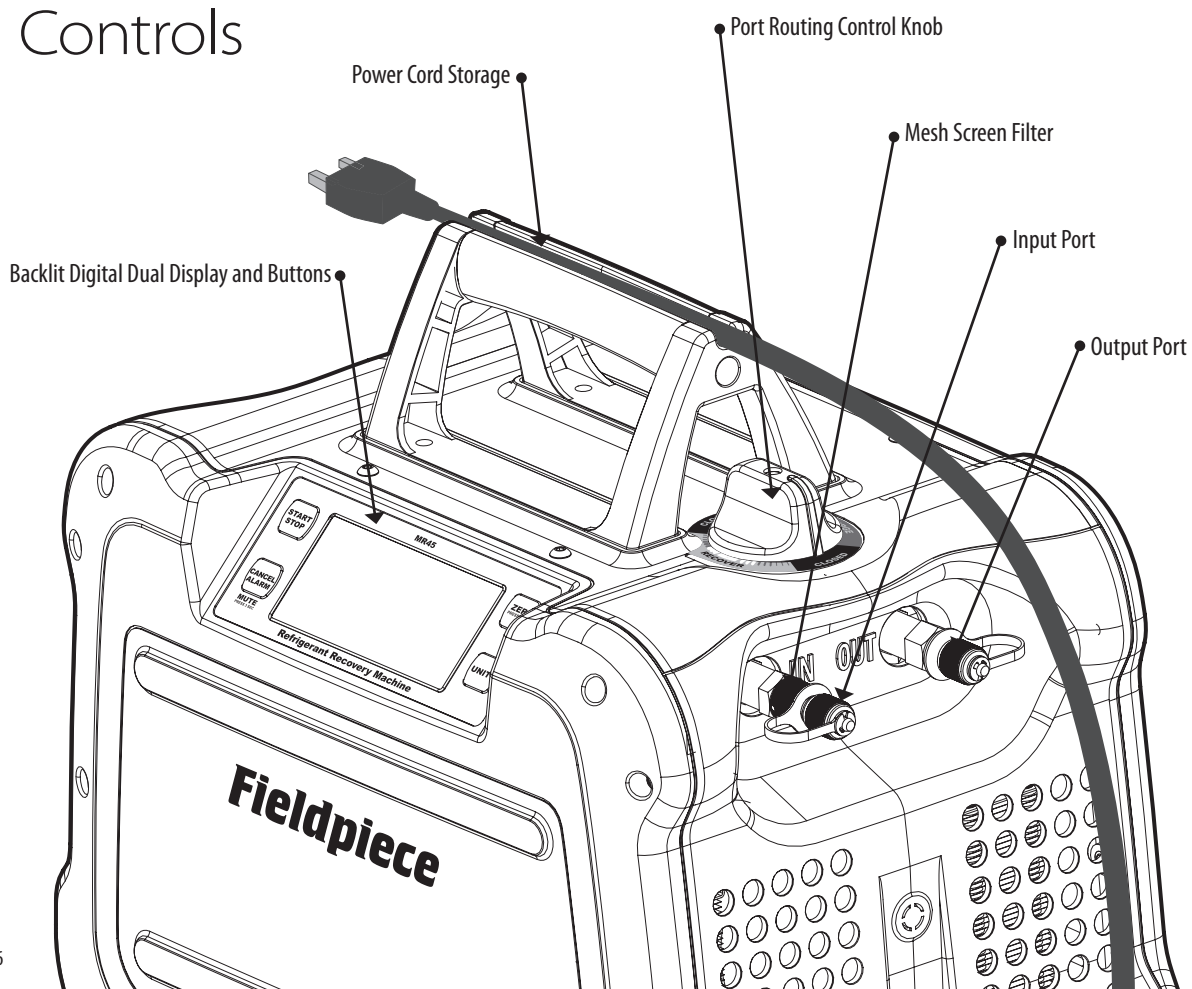

Display and Buttons

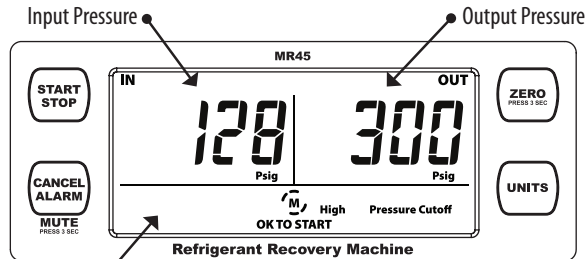

• Status Icons and Messages

START/STOP

Start or Stop the motor.

ZERO (press 3 seconds)

Zero pressure sensors. Ports must be open to atmosphere.

CANCEL ALARM

Cancel alarm currently sounding (temporarily mute).

MUTE (press 3 seconds)

Toggle mute for all sounds (setting is saved).

UNITS

Select pressure/vacuum units.

Status Icons and Messages

 The icon rotates when the motor is running.

 The icon is shown when MR45 is set to MUTE.

OK TO START

Motor stopped. Temperatures, voltages, and pressures are currently safe to start the motor again.

COMPLETE

Motor stopped. Purge or recovery has reached 10”Hg or 20”Hg (25 cmHg or 50 cmHg) vacuum for 10 sec.

Input Closed

Cannot zero pressures. Open input port.

Output Closed

Cannot zero pressures. Open output port.

High Voltage Warning

Motor stopped. Voltage was above 130 VAC.

Low Voltage Warning

Motor stopped. Voltage was below 95 VAC.

High Pressure Cutoff

Motor stopped. Output (cylinder) approached dangerous pressure.

Low Pressure Cutoff

Motor stopped. Input reached 10”Hg or 20”Hg (25 cmHg or 50 cmHg) vacuum for 10 sec.

Motor Fault 1

Motor stopped. Motor temp. measured above operating range.

Motor Fault 2 (“throttle” shows on display)

Motor stopped. Motor current (amps) rose above operating range. Throttle RECOVERY to reduce cylinder pressure (page 19).

Motor Fault 3

Motor stopped for unknown reason.

Port Routing Control

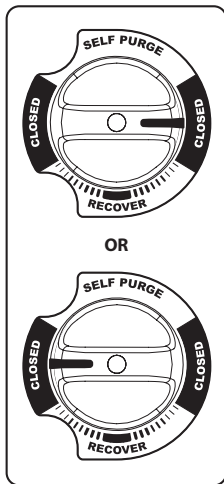

OR

CLOSED

- Input and Output closed.
- Set to either closed position to close off both ports during setup.

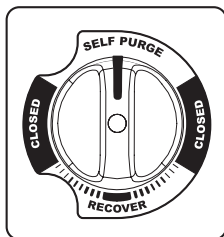

SELF PURGE

- Input closed, Output open.
- After recovery is complete, set to this position to close the IN port before you START the purge.



RECOVER

- Input and Output fully open.
- Set to this fully open position for most of the recovery process.

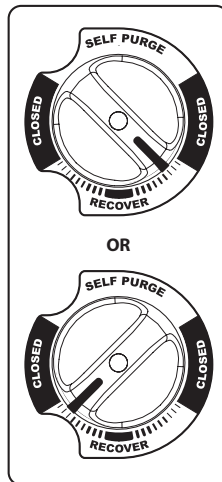

OR

RECOVER (throttled)

- Input and Output partially open.
- Rotate away from RECOVER in either direction to reduce liquid slugging if knocking occurs. This slows the flow of refrigerant so the machine operates more smoothly.
- Only throttle as much as needed for smooth operation.

MR45 Refrigerant Flow

Refrigerant liquid and vapor are pulled through the machine by the pressure difference created by the compressor. For maximum performance, increase the IN pressure and reduce the OUT pressure. See Tech Tips (page 12).

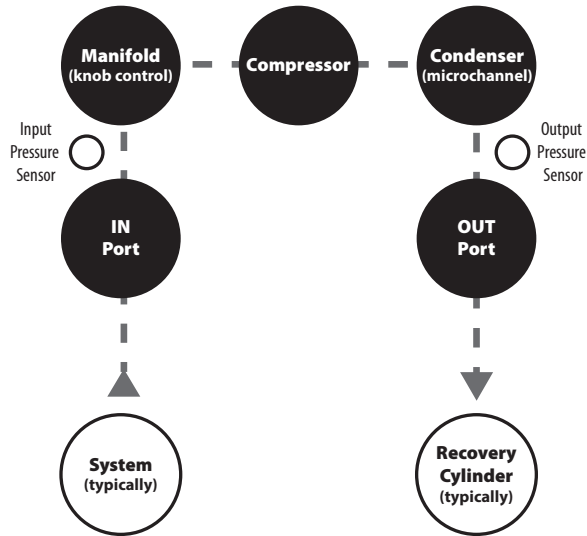

Dynamic Pressure Measurement

MR45 pressure readings are designed only for monitoring pressures. Do not use MR45 for diagnostic pressure measurements.

If a system's pressure is stable, MR45 pressure readings will be close to your other pressure gauges.

If a system's pressure is changing, pressure measurements at different locations within that system will be different. For every 3 feet of 1/4" hose, the pressure may have a difference of approximately ± 20 psig (± 150 kPa).

Functions

Self Test

Perform this test to ensure the high pressure cutoff and pump are operational.

1. Set knob to RECOVERY.
2. Open IN port to air.
3. Connect a ball valve to OUT port. (Included caps are not sealed.)
4. Close the ball valve.
5. Press START to create a pressure at the OUT port.
6. MR45 is working well if High Pressure Cutoff occurs around 550 psig (3800 kPa) within 45 seconds. Cutoff time can increase if a hose is placed in front of your ball valve.

Self Purge

Use the SELF PURGE feature at the end of every recovery to pump the last bit of refrigerant out of MR45. Benefits include increased machine life, reduced environmental impact, and most importantly to prevent refrigerant mixing.

1. After recovery is complete, set knob to SELF PURGE. This closes the IN port and routes the MR45 condenser to the intake of the MR45 compressor.
2. Press START to empty MR45 into the recovery cylinder.
3. Once 10" Hg (25 cmHg) is reached for 10 seconds, the motor stops automatically.

Purging a Recovery Cylinder

When the cylinder pressure is higher than expected you may have non-condensables at the top of the cylinder. Use a second deeply evacuated cylinder to pull out the non-condensables.

1. Leave pressurized cylinder undisturbed overnight.
2. Use a vacuum pump to evacuate another cylinder.
3. Use your manifold gauges to connect the closed vapor ports of the two cylinders.
4. Measure the vapor temperature of the pressurized refrigerant cylinder.
5. Use a P/T chart or digital manifold to find specified pressure.
6. Open the evacuated vapor port.
7. Open (purge) the pressurized vapor port until pressure is reduced to 5 psi above specified pressure.
8. Close valves.
9. If desired, repeat in 15 minutes to allow the tank to settle again.

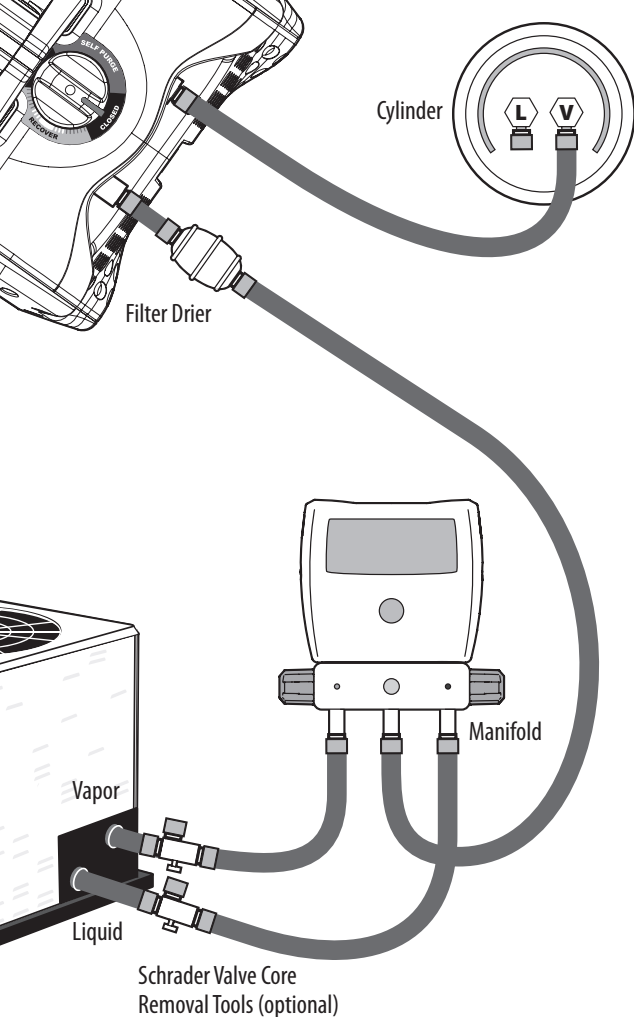

Direct Liquid/Vapor Recovery

This is the typical recovery method. Vapor and liquid lines are routed through your manifold, into MR45, and out to the recovery cylinder.

1. Close valves of recovery cylinder, MR45, and manifold.
2. Set up as shown in the diagram.
3. Open valves of hoses and removal tools.
4. Set MR45 to RECOVER.
5. Open high side of manifold for liquid recovery.
6. To purge air from hoses, briefly unseat hose fitting at cylinder until vapor is seen. Unseat hose fitting at low side of manifold to purge low side hose.
7. Fully open vapor valve of recovery cylinder.
8. Press START to begin recovery.
9. Adjust the knob as needed to throttle refrigerant flow if liquid slugging (knocking) occurs.
10. When liquid recovery is complete, open low side of manifold for vapor recovery.
11. MR45 stops automatically after vacuum reaches 10"Hg (25 cmHg) for 10 seconds. For a deeper vacuum, press START to continue recovery. MR45 stops again after vacuum reaches 20"Hg (50 cmHg) for 10 seconds. Press STOP to manually halt recovery at any time.
12. Set knob to SELF PURGE and press START to empty MR45. MR45 stops automatically after vacuum reaches 10"Hg (25 cmHg) for 10 seconds.
13. Close manifold and cylinder valves after self purge is complete.
14. Remove hoses from MR45, set knob to RECOVER, and cap ports.

Schrader Valve Core
Removal Tools (optional)

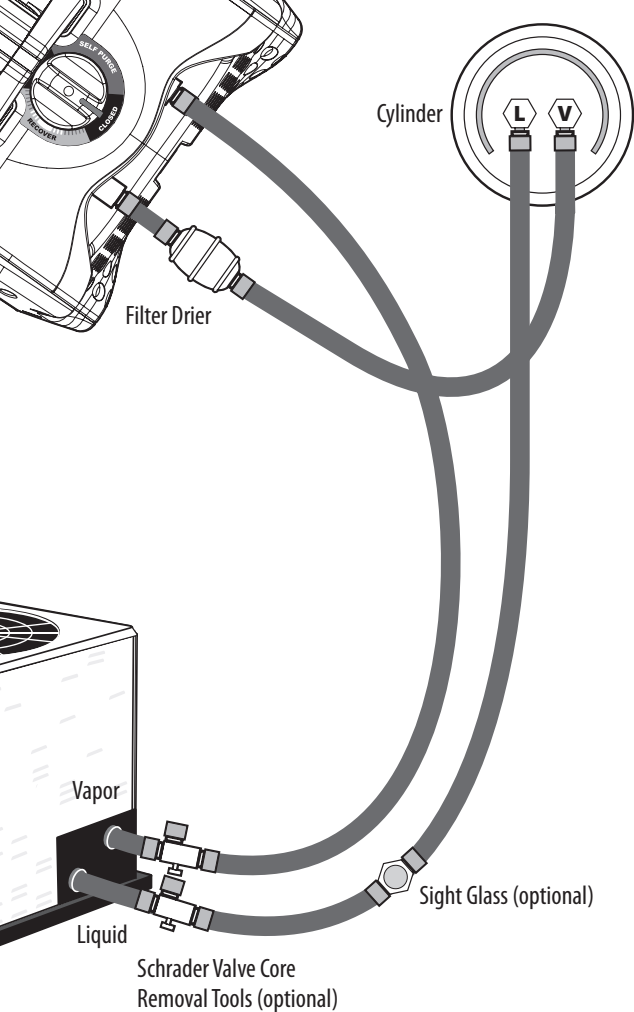

Push/Pull Recovery

This method is only for larger systems with at least 30 lbs (14 kg) of liquid refrigerant. It's used to recover liquid before recovering vapor.

1. Close valves of recovery cylinder and MR45.
2. Set up as shown in the diagram.
3. Open valves of liquid hose and removal tool at liquid system port.
4. To purge air from system liquid hose, briefly unseat hose fitting at cylinder's liquid port until vapor is seen.
5. Fully open liquid valve of recovery cylinder and allow to pressurize.
6. Set MR45 to RECOVER.
7. Press START to begin recovery.
8. Fully open vapor valve of recovery cylinder.
9. To purge air from hoses briefly unseat hose fitting at vapor system port until vapor is seen.
10. Open valves of vapor hose and removal tool at vapor system port.
11. When liquid recovery is complete, press STOP to stop motor.
12. Close all valves and proceed to Direct Vapor Recovery (page 25).

Troubleshooting

Status Messages

Input Closed

Cannot zero the displayed pressure because pressure sensor not open to atmosphere. Open input port.

Output Closed

Cannot zero the displayed pressure because pressure sensor not open to atmosphere. Open output port.

High Voltage Warning

Voltage was above 130 VAC. Motor stopped. Ensure power network voltage is between 95 and 130 VAC @ 60 Hz.

Low Voltage Warning

Voltage was below 95 VAC. Motor stopped. Check power network to ensure voltage is between 95 and 130 VAC @ 60 Hz.

High Pressure Cutoff

Output (cylinder) reached dangerous pressure. Motor stopped. Ensure all valves after the output port are open. The cylinder may need to be cooled or replaced to reduce pressure.

Low Pressure Cutoff

Input reached final recovery vacuum. Motor stopped. It's normal to see this after RECOVERY or SELF PURGE is complete. If unexpected, ensure valves before the input port are open and the knob is not set to CLOSED.

Motor Fault 1

Motor temperature measured above operating range. Motor stopped. Extremely high ambient temperature, extended liquid recovery time, or high cylinder pressure can be the cause. Allow time for the motor to cool down before resuming, and throttle the RECOVERY (page 19).

Motor Fault 2

Motor current (amps) rose above operating range. Motor stopped. Extremely high ambient temperature, harsh liquid slugging, extended recovery time, or high cylinder pressure can be the cause. Throttle RECOVERY and start the motor. If fault occurs again, throttle even more and start the motor (page 19).

Motor Fault 3

Motor stopped for unknown reason. If this occurs repeatedly, there may be something wrong with MR45.

Other Symptoms

MR45 never reaches 10"Hg or 20"Hg vacuum.

Check for a leakage before the input port.

For 10"Hg vacuum, the recovery cylinder should be below 475psig.

For 20"Hg vacuum, the recovery cylinder should be below 230psig.

Input port shows frost or signs of leakage.

Ensure the grooved input fitting is hand tight before tightening the hex nut (page 30).

Recovery is slower than normal.

There could be an input blockage. Check mesh screen filter for blockage. Ensure knob is set to RECOVER.

Display does not turn on when plugged in.

Ensure power cord and outlet are okay.

Excessive noise during liquid recovery.

MR45 is experiencing a high load. Rotate the knob of MR45 to throttle the refrigerant flow.

Maintenance

General

Wipe with damp cloth to clean the exterior.
Do not use solvents.

To extend the life of internal seals, occasionally pump a teaspoon of mineral oil through MR45.

Mesh Screen Filter

When the mesh screen filter becomes dirty and clogged, it means it's working to keep your MR45 working well for a long time. You need to clean or replace this screen often. Visit our website for information on obtaining extra mesh screens.

1. Loosen (counter clockwise) the securing hex nut on the IN port.
2. Unscrew (counter clockwise) the grooved input fitting.
3. Clean or replace the mesh screen.
4. Hand tighten (clockwise) the grooved input fitting.
5. Tighten (clockwise) the securing hex nut with 1/8 turn with a wrench.

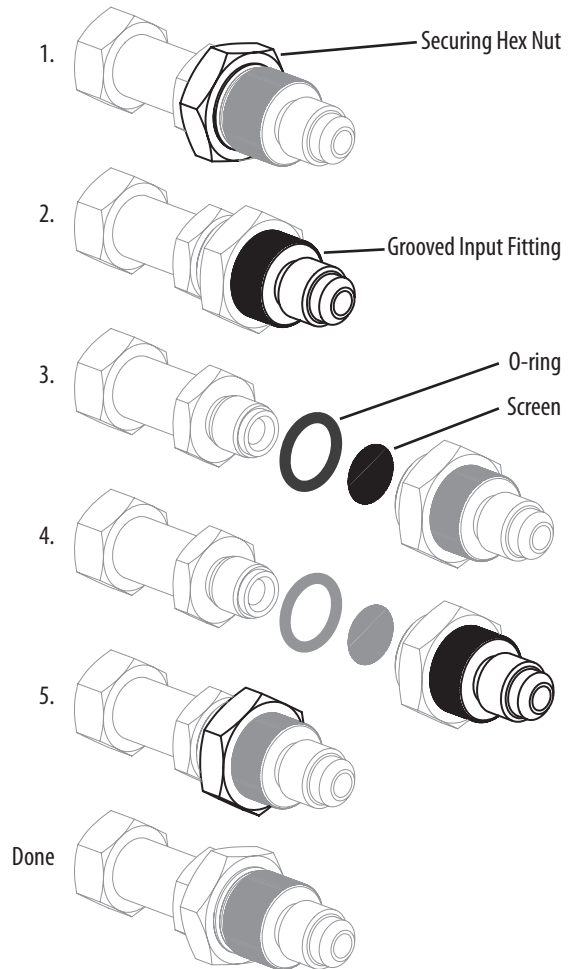

Limited Warranty

This machine is warranted against defects in material or workmanship for one year from date of purchase from an authorized Fieldpiece dealer. Fieldpiece will replace or repair the defective unit, at its option, subject to verification of the defect.

This warranty does not apply to defects resulting from abuse, neglect, accident, unauthorized repair, alteration, or unreasonable use of the machine.

Any implied warranties arising from the sale of a Fieldpiece product, including but not limited to implied warranties of merchantability and fitness for a particular purpose, are limited to the above. Fieldpiece shall not be liable for loss of use of the machine or other incidental or consequential damages, expenses, or economic loss, or for any claim of such damage, expenses, or economic loss.

State laws vary. The above limitations or exclusions may not apply to you.

Obtaining Service

Visit www.fieldpiece.com/rma for the latest information on how to obtain service. Warranty for products purchased outside of the U.S. should be handled through local distributors. Visit our website to find your local distributor.

MR45

© Fieldpiece Instruments, Inc 2022; v28