

Version 6:05.02.18

# ZODIAC

## FREETALK PRO

---

---

PROFESSIONAL LICENSE FREE 446/444 MHZ RADIO

User's Manual

English / Swedish / Norwegian





## User Guide ENG

**ZODIAC**



## ■ Introduction

Thank you for purchasing Zodiac Freetalk Pro. Zodiac Freetalk Pro is a PMR-product (Private Mobile Radio) that lets you talk to as many people you wish, as often as you like, with no need for a license, subscription or tax payment. It is very easy to use so even children can handle it.

Please read through this manual carefully for many features of this model.

This user guide is also available on our web site [www.zodiac.se](http://www.zodiac.se).

## ■ Table of contents

<b>Radio controls/functions</b>	<b>page 4</b>
<b>Icons Guide</b>	<b>page 5</b>
<b>Operation Guide</b>	<b>page 6</b>
Power ON/OFF	page 6
Transmitting/Receiving	page 6
Volume adjustment	page 6
Channel selection	page 6
Scan channels	page 7
CTCSS ON/OFF	page 7
LCD back light	page 8
Monitoring	page 8
Keypad lock/unlock	page 8
Function settings	page 9
Tone call	page 9
Power Save Modus	page 9
VOX ON/OFF	page 10
VOX sensitivity	page 10
TX/RX Different Channels	page 10
Keypad Tone	page 11
Auto-Power	page 11
Time-Out Timér	page 11
Squelch	page 12
Repeater	page 12
Tone Call	page 12
VOX ON/OFF	page 12
Memory Channel	page 13
Hazard (Emergency) Channel	page 13
Dual Channel Watch	page 14
Memory and Hazard Channel	page 14
Restore to factory default settings	page 15
<b>Installing/removing of Battery</b>	<b>page 15</b>
<b>Pack Battery Charging</b>	<b>page 16</b>
<b>PMR Channel Frequency Table</b>	<b>page 17</b>
<b>CTCSS Frequency Table Optional</b>	<b>page 17</b>
<b>Accessories</b>	<b>page 18</b>
<b>Safety Informations Specifications</b>	<b>page 18</b>
<b>Warranty</b>	<b>page 19</b>
<b>Declaration of conformity</b>	<b>page 20</b>

## Radio controls/functions

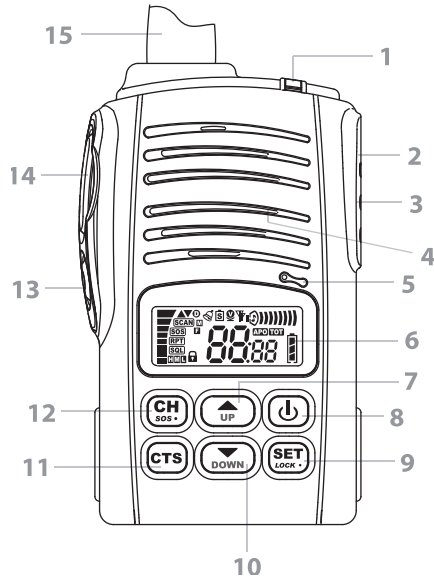

- |                             |                            |
|-----------------------------|----------------------------|
| 1. LED indicator            | 8. Power key               |
| 2. External speaker jack    | 9. Function key            |
| 3. External microphone jack | 10. DOWN key               |
| 4. Speaker area             | 11. CTCSS key              |
| 5. Microphone               | 12. Channel key            |
| 6. LCD screen               | 13. Monitor/back light key |
| 7. UP key                   | 14. PTT key (Push-To-Talk) |
|                             | 15. Antenna                |

**ZODIAC**

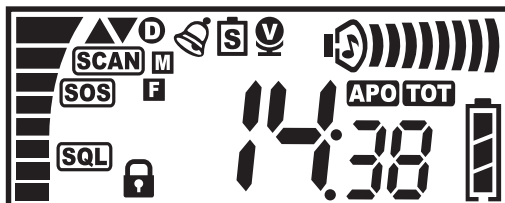

## Icons Guide



	Tone call
	Auto-Power Save
	VOX (Voice-activate system)
	Keypad tone
	Volume
	Auto-Power-Off
	TX Time-Out-Timér
	Battery power
	CTCSS number
	Channel number
	Squelch level
	Keypad lock
	Hazard (Emergency) channel
	Memory Channel
	Scanning
	Signal strength indicator
	Dual channel watch



## ■ Operation Guide

### 1. Power ON/OFF

Hold  about 0.5 sec to power radio. While power ON, hold  about 1.5 sec to turn power off.

### 2. Transmitting/Receiving







While holding , speak to the microphone area. LED glows red during transmission. To receive, release . LED glows green when receiving.

※ Keep about 10 cm from microphone area when speaking slowly and clearly.

### 3. Volume adjustment







Momentarily press repeatedly on  to adjust volume louder. Momentarily press repeatedly on  to adjust volume lower. Press and hold  or  to swiftly adjust volume. Do adjustment as you need.

※ Caution: For external mic/ear user, adjust volume starting from lowest level.

### 4. Channel selection









Momentarily press . While channel icon blinks, temporarily press repeatedly on  or  to select channel. To preset channel, temporarily press  or .

### 5. Scan Channel







Momentarily press . While channel icon blinks, hold on  or  about 2 sec. to start scanning of channel. Jumping of channel numbers increasingly or decreasingly indicates scan in progress. Scan stops when it detect a busy channel. Temporarily press on  or  will disable scan and select the final busy channel.



※Note: To scan, turn off CTCSS codes.

### 6. CTCSS ON/OFF



Hold on  for about 2 sec. to enable CTCSS. Hold on  again for about 2 sec. to disable. While CTCSS is enabled, press temporarily  or  repeatedly to select CTCSS.

## 7. LCD back light ON/OFF

Temporarily press  to turn back light ON. Temporarily press  again to turn back light OFF or it will automatically turn OFF after 5 sec. lighting.

## 8. Monitoring





Hold on  for about 1 sec. Static is heard if the channel is clear or any voice on this channel can be heard regardless of CTCSS settings. LED glows green.

※ Monitor is used for following purposes

- To receive weak signal due to distance or for signal intermittently received.
- To receive all signals on same channel even with different CTCSS.

## 9. Keypad lock/unlock



Hold on  for about 3 sec until  shows on the screen to confirm keypad lock is enabled. To unlock keypad, hold on  again for about 3 sec until  clear from the screen.

※ When keypad lock is enabled, volume control and program features are locked to prevent accidental function changes.

## 10. Function settings



Temporarily press **SET LOCK** to enable menu mode on screen. Use **UP** or **DOWN** to scroll menu item between 1 and 9.

### **F1** Tone Call

Under menu item 1, tone call 1 - 7 can be selected.

Factory default: 1



### **F2** Power Save Mode

Under menu item 2, power save modes 1-1 to 1-4 can be selected. Choose 1-4 if talk time is short for best power saving.

Factory default: OFF



**F3** VOX ON/OFF

Under menu item 3, VOX ON/OFF can be selected.

Factory default: OFF

**F4** VOX sensitivity

Under menu item 4, VOX sensitivity levels 1 - 9 can be selected. L9 is least sensitive.

Note: If VOX is disabled, this feature is automatically disabled.

**F5** TX/RX Different Channels

This feature is not in use for this model.

**F6** Keypad Tone

Under menu item 6, select ON/OFF. The beep sounds very weakly at OFF.

Factory default: ON

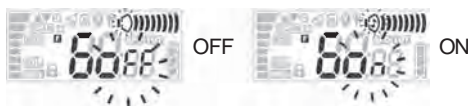

**F7** Auto-Power

Under menu item 7, choose OFF/03/10/30/60 min. depending on your need. If 03 is selected, the radio automatically turns power off if none of the keys is operated or no signal received after 3 min.

Factory default: OFF

**F8** Time-Out Timér

Under menu item 8, choose OFF/30/60/120/180 depending on your need. If 30 is selected, the radio will stop transmission if continous talk exceeds over 30 sec and the radio will automatically swift to receiving mode.

Factory default: OFF

**F9** Squelch

Under menu item 9, choose squelch level 1 to 7 depending on your need. If the squelch level is at 0, the static sound is heard all the time. If setting at 1, the radio is best to pick up weak signal but

susceptible to interferences. Squelch level 7 is the least sensitive and suited for use against high interferences.

Factory default: 3



### **F10** Repeater

This feature is not in use for this model.

## 11. Tone Call



Holding **PTT** temporarily press **CTS** to send tone call to other receivers. (For selection of tone call, refer to **F1** .

## 12. VOX ON/OFF



Holding **PTT**, temporarily press **SET LOCK** to enable VOX. To disable it, hold **PTT** and temporarily press **SET LOCK** again. For programming of VOX sensitivity, refer to **F4** .

- ※ While VOX is enabled, press of **PTT** is no longer required during transmission. Just talk into the microphone area with appropriate sound (depending on VOX sensitivity).

### 13. Memory Channel



1. Holding **CH SOS**, temporarily press **DOWN** to select memory channel. The memory channel is marked with a **M**. (Refer to 16 for setting of memory channel.)
2. Holding **CH SOS**, temporarily press **UP** to restore to preset channel.

Factory default: CH01 and CTCSS OFF

### 14. Hazard (Emergency) Channel



Hold **CH SOS** for about 3 sec to enable hazard channel until **SOS** shows on the display. To disable hazard channel, hold **CH SOS** for about 3 sec until **SOS** disappears.

Factory default: CH01 and CTCSS OFF

## 15. Dual channel watch



Press temporarily **CH SOS** until channel number blinks. Hold both **UP** and **DOWN** simultaneously for about 1 sec and release them to enable this feature. The preset and memory channel blink each time on the display. When signal on these channels is received, sound can be heard and the receiving channel is seen on the display. This channel is fixed for about 8 sec to reply. After 8 sec if no signal is received, channel rotation begins.

To select channel for use during channel rotation, temporarily press **PTT** if the desired channel is seen. This channel is on standby for about 8 sec before channel rotation begins.

To disable this, temporarily press both **CH SOS** and **SET LOCK** simultaneously.

## 16. Memory and hazard channels

1. Select favorite channel and CTCSS.



2. Hold **CH SOS** and **SET LOCK** simultaneously first. With **CH SOS** still being hold, release **SET LOCK** and temporarily press **UP** or **DOWN** repeatedly until



**M** or **SOS** shows on the display.

(**M** shows the memory channel. **SOS** shows the hazard channel).

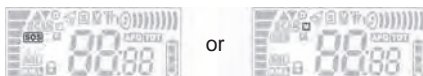

- When favorite channel shows, temporarily press **SET LOCK** to select it.
- After memorization, release **CH SOS** to jump out of memorization mode.

## 17. Restore to factory default settings

- Turn power OFF.
- Hold **SET LOCK** and turn power ON simultaneously.

## ■ Installing/removing battery pack

### To install

- Place the battery pack into battery compartment as in illus #1.
- Push battery pack forward as in illus #2. It will lock into compartment.

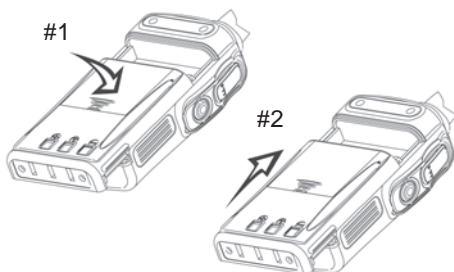

**ZODIAC**

**To remove**

1. Holding the radio in one hand, push down battery latch as in illus #3.
2. Slide battery pack backwards as in illus #4.

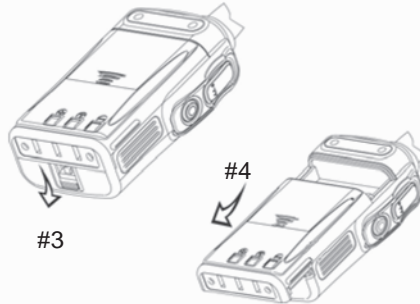
**Battery charging**

1. Power drop-in charger with standard AC/DC wall charger #1.
2. Drop radio with installed battery into the battery-with-radio slot #2.
3. Drop spare battery pack into the battery-only slot #3.

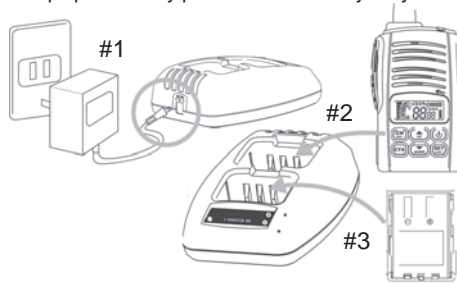
**ZODIAC**

Single or dual charging is possible. Each LED light individually indicates charging slot in process. LED turns off when battery in slot is fully charged.

### PMR Channel frequency table

Channel	Frequency (MHz)	Channel	Frequency (MHz)
1	446.00625	8	446.09375
2	446.01875	9	444.60000
3	446.03125	10	444.65000
4	446.04375	11	444.80000
5	446.05625	12	444.82500
6	446.06875	13	444.85000
7	446.08125	14	444.97500

### CTCSS frequency table

01=67.0Hz	11= 97.4Hz	21=136.5Hz	31=192.8Hz
02=71.9Hz	12=100.0Hz	22=141.3Hz	32=203.5Hz
03=74.4Hz	13=103.5Hz	23=146.2Hz	33=210.7Hz
04=77.0Hz	14=107.2Hz	24=151.4Hz	34=218.1Hz
05=79.7Hz	15=110.9Hz	25=156.7Hz	35=225.7Hz
06=82.5Hz	16=114.8Hz	26=162.2Hz	36=233.6Hz
07=85.4Hz	17=118.8Hz	27=167.9Hz	37=241.8Hz
08=88.5Hz	18=123.0Hz	28=173.8Hz	38=250.3Hz
09=91.5Hz	19=127.3Hz	29=179.9Hz	
10=94.8Hz	20=131.8Hz	30=186.2Hz	

## Optional accessories

Battery pack NI-MH 7,2V /1350 mAh (art.nr 47308)

Desk charger (art.nr. 47307)

Adapter ADA 12V/600mA (art.nr. 47306)

External speaker/microphone (art.nr. 47301)

External earphone/microphone (art.nr. 47302)

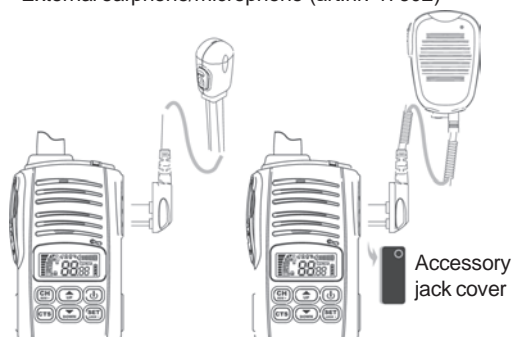

## Safety information

1. Use only the supplied antenna. Unauthorized antennas, modifications or attachments could damage the radio and changes or modifications not expressly approved by the party responsible for the compliance could void the authority to operate the radio.
2. Avoid storing in high temperature or humid place for long time
3. If strange smell or smoke comes off the radio, dispatch it to service center immediately
4. Turn to lowest volume if external mic/speaker is used, then adjust appropriately
5. Never use other power sources for charging other than the standard charger set designed for this radio model
6. Take off battery pack if out of use for long time

**ZODIAC**

## ■ Specifications

Mode	FM (F3E)
SAR	0.48 W/kg
Number of channels	14 (446.00625-444.97500MHz)
Number of CTCSS	38 (67.0-250.3Hz)
Antenna gain	1.8dBi
Antenna impedance	50Ω
Frequency stability	+/- 2.5kHz
Frequency resolution	12.5kHz
Power supply	7,2V
RX current	<40mA (auto save off)
Audio output power	> 500mW
Sensitivity (12dB sinad)	< 0.22 μV
Operating temp. range	-30°C to +70°C
Weight (incl. battery)	250g
External mic connector	2.5 mm (d), 3-conductor
External SP connector	3.5 mm (d), 2-conductor

## ■ Warranty

Zodiac will give 12 months warranty against failures made by the manufacturer from the date of purchase. The warranty will not cover damage made by the user, the user opening the equipment, moist, dirt, heat or cold. It will also not cover lightning / over voltage.

Please contact your dealer if a problem with the equipment arises.



**ZODIAC**

20





## Bruksanvisning SVE

**ZODIAC**



## ■ Introduktion

Tack för att du valt Zodiac Freetalk Pro som din nya kommunikationsradio.

Zodiac Freetalk Pro är en PMR-radio (Private Mobile Radio) som ger dig möjlighet att prata med så många människor du vill, så ofta du vill, utan licens eller samtalsavgifter. Varje enhet ska användas med en eller flera Zodiac Freetalk Pro apparater.

Läs igenom bruksanvisningen innan du använder apparaten så att du har tillräcklig kunskap om funktionerna.

Bruksanvisningen finns även på vår hemsida, [www.zodiac.se](http://www.zodiac.se).



## **Innehåll**

<b>Beskrivning av radion</b>	<b>side 4</b>
<b>Beskrivning av displayen</b>	<b>side 5</b>
<b>Grundfunktioner</b>	<b>side 6</b>
Power ON/OFF	side 6
Sändning/mottagning	side 6
Volymkontroll	side 6
Val av kanal	side 6
Kanalsökning	side 7
Pilottonsystem ON/OFF (CTCSS)	side 7
Bakgrundsbelysning	side 8
Monitor	side 8
Knapplås	side 8
Val av funktioner	side 9
Anropstoner	side 9
Strömsparkläget	side 9
VOX (röststyrning)	side 10
VOX känslighet	side 10
TX/RX (olika kanaler)	side 10
Tangentljud	side 10
Automatisk avstängning	side 11
Time-Out Timer	side 11
Squelch / Brusspär	side 12
Repeater	side 12
Anropston	side 12
VOX ON/OFF	side 12
Minneskanal	side 13
Nödkanal	side 13
2-kanalsspänning	side 13
Val av minneskanal och nödkanal	side 14
Återställa til fabriksinställning	side 15
<b>Isättning/urtagning av batteripacket</b>	<b>side 15</b>
<b>Laddning av batteri</b>	<b>side 16</b>
<b>Kanalfrekvenstabell</b>	<b>side 17</b>
<b>Pilottontabell</b>	<b>side 17</b>
<b>Tillbehör</b>	<b>side 18</b>
<b>Säkerhetsanvisningar</b>	<b>side 18</b>
<b>Specifikationer</b>	<b>side 19</b>
<b>Garanti</b>	<b>side 19</b>

## ■ Beskrivning av radion

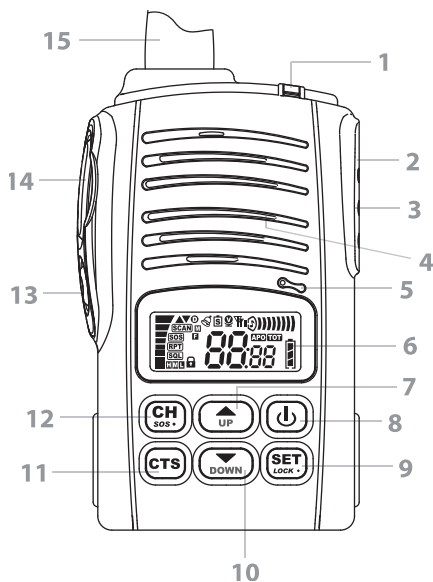

- |                       |  |
|-----------------------|--|
| 1. LED                | 9. Funktionsknapp                        |
| 2. Yttre högtalarjack | 10. NER-knapp                            |
| 3. Yttre mikrofonjack | 11. Pilotton-knapp (CTCSS)               |
| 4. Högtalare          | 12. Kanal-knapp                          |
| 5. Mikrofon           | 13. Knapp för bakgrundsbelysning/monitor |
| 6. LCD Display        | 14. PTT-knapp (Push-To-Talk)             |
| 7. UPP-knapp          | 15. Antenn                               |
| 8. Strömbrytare       |  |

**ZODIAC**

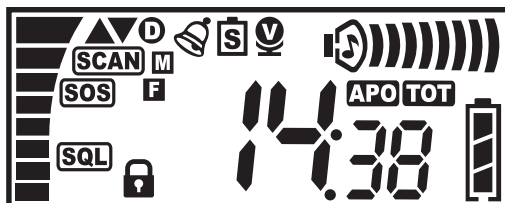

## Beskrivning av displayen



-  Anropston
-  Auto-Power
-  VOX (röststyrning)
-  Knappklick
-  Volym
-  Auto-Power-Off
-  TX Time-Out-Timer
-  Batteristatus
-  Piloton (CTCSS code)
-  Kanalnummer
-  Squelch nivå (brusspärnivå)
-  Knapplås
-  Nödkanal
-  Minneskanal
-  Kanalsökning (scanning)
-  Signalstyrkeindikator
-  2-kanalpassning

## ■ Grundfunktioner

### 1. Power ON/OFF

Tryck ner  för att slå på radion. För att slå av, tryck ner och håll  i ca. 2 sekunder.

### 2. Sändning/Mottagning







Tryck ner och håll , och prata med vanligt röst i mikrofonen. LED lampan lyser rött vid sändning.

Släpp  för mottagning. LED lampan lyser grönt vid mottagning.

※ Håll radion med mikrofonen ca. 10 cm från munnen medan du talar med vanligt röst.

### 3. Volymkontroll



Tryck ner  för att öka volymen. Tryck ner  för att minska volymet. Tryck ner och håll  eller  för att snabbt justera ljudet.

※ Notera! Vid användning av extra mikrofon eller handsfree, börja från lägsta volym vid volymjustering.

### 4. Val av kanal



Tryck ner **CH**. Medan kanalindikatoren blinkar i displayen, tryck ner **UP** eller **DOWN** för att välja önskad kanal. För att spara kanalen, tryck på **CH**.

## 5. Kanalsökning (scanning)



Tryck ner **CH**. Medan kanalindikatoren blinkar, tryck ner och håll **UP** eller **DOWN** i 2 sekunder för att börja kanalsökningen. När kanalnumret gör ett hopp, antingen upp eller ner, visar detta att kanalsökningen är aktiv. Sökningen stoppar när det detekteras en upptagen kanal. Kort tryck på **CH** eller **SET** avslutar sökningen och senaste upptagna kanal väljs.

- ※ Vid kanalsökning skall Pilottonsystemet (CTCSS) vara inaktiverat, dvs. att radion inte söker CTCSS tonerna

## 6. Pilottonsystem ON/OFF (CTCSS)





Tryck på **CTS** för att aktivera pilotton.

När Pilottonsystemet är aktiverat, tryck **UP**

eller  för att välja önskad pilotton.

Spara önskat värde genom att trycka ner .

## 7. Bakgrundsbelysning

Tryck ner  för att slå på bakgrundsbelysning i displayen. Tryck ner  på nytt för att stänga av belysningen eller vänta 5 sekunder för automatisk avstängning.

## 8. Monitor

Tryck ner och håll  i ca. 1 sekund. Du hör nu brus om kanalen är ledig och alla signaler på kanalen oberoende av pilottoninställningen. LED lampan lyser grönt.

Monitor används för

- ※ a. att motta svaga signaler pga. avstånden eller för att motta periodiska signaler
- b. att motta alla signaler på en kanal även vid olika pilottoner.





## 9. Knapplås



Låst



Öppen

Tryck och håll  i ca. 3 sekunder till  visas i displayen som bekräftar att knapplåsen är inkopplad. För att koppla ur knapplåsen, tryck ner och håll  på nytt i 3 sekunder tills  försvinner.

- ※ När knapplåset är inkopplat, kommer volymkontrollen och funktionsval vara spärrade för att förhindra oönskade ändringar.

## 10. Val av funktioner



Tryck ner **SET** för att öppna menyn i displayen.  
Använd **UP** och **DOWN** för att bläddra i de olika menyerna för funktionsval 1 - 10.

### **F1** Anropston

Under funktionsval 1 väljer du mellan 7 olika anropstoner (1 - 7).

Fabriksinställning: 1



### **F2** Strömsparkläge

Under funktionsval 2 väljer du mellan olika ström-sparinställningar. Välj 1-4 för lägsta strömanvändning om du som oftast har mycket korta samtal.

Fabriksinställning: OFF



**F3 Röststyrning (VOX)**

Under funktionsval 3 kan du välja om VOX-funktionen skall inkopplas eller urkopplas.

Fabriksinställning: OFF

**F4 VOX känslighet**

Under funktionsval 4 kan du välja mellan 9 känslighetsnivåer för VOX. Nivå L9 ger lägsta känslighet. Se även pkt. 12.

Notera! Denne funktionen blir automatisk borttagen om VOX är urkopplad under **F3**.

**F5 TX/RX olika kanaler**

Funktionen används inte i Sverige.

**F6 Tangentljud**

Under funktionsval 6 kan du välja om knappklick skall inkopplas eller urkopplas. Knappklicket ger en ton varje gång en knapp trycks ner. Endast svag ton vid OFF.

Fabriksinställning: ON





**F7 Automatisk avstängning**

Under funktionsval 7 kan du välja mellan OFF/30/60/120 min för Auto-power. Om 30 väljs, kommer radion stängas av automatisk om inte några knapptryckningar sker eller några signaler tas emot i löpet av 30 minuter.

Fabriksinställning: OFF

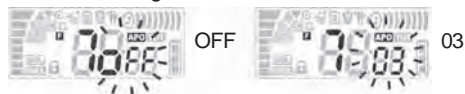
**F8 Time-Out Timér**

Under funktionsval 8 kan du välja mellan OFF/30/60/90/180 sekunder för Time-Out Timérn. Om 30 väljs, kommer radion stoppa sändningen vid konstant tal i mer än 30 sekunder och automatisk växla till mottagning.

Fabriksinställning: OFF

**F9 Squelch**

Under funktionsval 9 kan du välja mellan 7 nivåer för squelch. Nivå 0 ger högsta känslighet och konstant brus. Nivå 1 är bäst vid svaga signaler, men är samtidigt känslig för störningar. Nivå 7 ger

lägst känslighet och är bäst anpassad för användning vid mycket störningar.

Fabriksinställning: 3



### **F10** Repeater

Funktionen används inte i Sverige.

## 11. Anropston



Under sändning ( **PTT** trycks ner), tryck **CTS** för att sända anropston til mottagare.

För val av anropston, se **F1** .

## 12. VOX ON/OFF

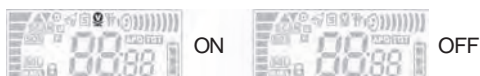

Under sändning ( **PTT** trycks ner), tryck **SET LOCK** för att koppla in VOX (röststyrningsfunktion).

För att koppla ur VOX, håll **PTT** och tryck **SET LOCK** igen.

För val av känslighet för VOX, se **F4** .

- ※ När VOX er inkopplat, är det inte nödvändigt att trycka **PTT** under sändning. Endast tal i mikrofonen med lämplig styrka (beroende av vald känslighet).

### 13. Minneskanal



1. Håll **CH** och tryck **DOWN** för att välja minneskanal. Minneskanalen är märkt vid **M**. (Se pkt. 17 för förhandsinställning av minneskanalen.)
2. Håll **CH** och tryck **UP** för att återvända till tidigare vald kanal. Fabriksinställning: CH01 och CTCSS OFF

### 14. Nödkanal



- För att koppla in nödkanalen, tryck **CH** ner i ca. 3 sekunder tills **SOS** visas i displayen.
- För att koppla ur nödkanalen, tryck **CH** ner i ca. 3 sekunder tills **SOS** forsvinner från displayen.

### 15. 2-kanalsspassning



Öppen

Tryck och håll **CH SOS** tills kanalindikatoren blinkar. Håll **UP** och **DOWN** samtidigt i ca. 1 sekund och släpp knapparna för att koppla in funktionen. Förhandsinställd kanal och minneskanal blinkar växlande i displayen. När en signal tas emot på dessa kanaler, visas kanalnumret i displayen. Denna kanal är låst i ca. 8 sekunder för att svara. Om inga signaler tas emot inom 8 sekunder, börjar kanalväxlande igen. För att välja en kanal för användning under kanalväxlande, tryck **ATT** när önskad kanal visas. Denna kanal kommer då vara i standby ställning i ca. 8 sekunder tills kanalväxlande börjar igen. För att förhindra detta, tryck ner samtidigt **CH SOS** och **SET LOCK**.

## 16. Val av minneskanal och nödkanal

1. Välj önskad kanal och pilotton (CTCSS).



2. Tryck och håll **CH SOS** och **SET LOCK** samtidigt. Medan **CH SOS** hålls, släpps **SET LOCK** och tryck därefter **UP** eller **DOWN** tills **MC** eller **SOS** visas i displayen.

**MC** visar minneskanalen och **SOS** nödkanal.

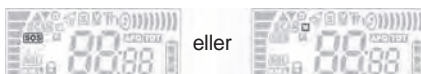

3. När önskad kanal visas, tryck **SET** för att välja denna kanal.
4. Efter lagring, släpp **CH** för att avsluta programmeringsläget.

### 17. Återställa till fabriksinställning

1. Slå av radion.
2. Håll **SET** tangenten inne samtidigt som du slår på radion.

## ■ Isättning/urtagning av batteripaket

### Isättning av batteri

1. Sätt i batteripaketet i batterifacket enligt figur #1.
2. Skjut batteriet uppåt enligt figur #2. Batteriet låsas på plats.

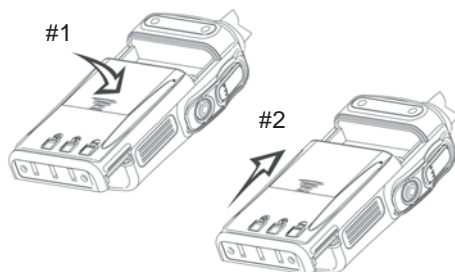

### Urtagning av batteri

1. Håll radion med en hand och skjut låshändeln till batterifacket enligt figur #3.
2. Skjut batteriet nedåt enligt figur #4.

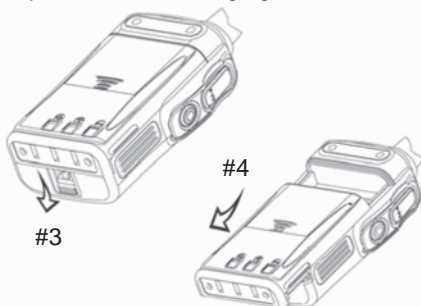

### Laddning av batteri

1. Plugga laddarens strömadapter i en 230V vägg-kontakt, se figur #1.
2. Placera radion med batteri i laddarens plats #2.

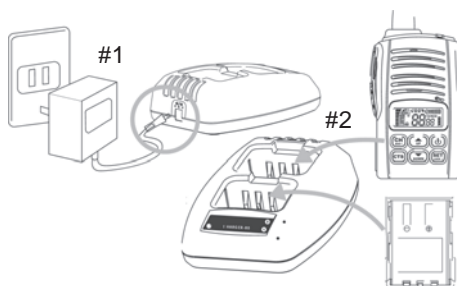

**ZODIAC**

### Kanal/frekvens tabell

Kanal Frekvens (MHz) Kanal Frekvens (MHz)

1	446.00625	8	446.09375
2	446.01875	9	444.60000
3	446.03125	10	444.65000
4	446.04375	11	444.80000
5	446.05625	12	444.82500
6	446.06875	13	444.85000
7	446.08125	14	444.97500

### Pilottontabell (CTCSS)

01=67.0Hz	11= 97.4Hz	21=136.5Hz	31=192.8Hz
02=71.9Hz	12=100.0Hz	22=141.3Hz	32=203.5Hz
03=74.4Hz	13=103.5Hz	23=146.2Hz	33=210.7Hz
04=77.0Hz	14=107.2Hz	24=151.4Hz	34=218.1Hz
05=79.7Hz	15=110.9Hz	25=156.7Hz	35=225.7Hz
06=82.5Hz	16=114.8Hz	26=162.2Hz	36=233.6Hz
07=85.4Hz	17=118.8Hz	27=167.9Hz	37=241.8Hz
08=88.5Hz	18=123.0Hz	28=173.8Hz	38=250.3Hz
09=91.5Hz	19=127.3Hz	29=179.9Hz	
10=94.8Hz	20=131.8Hz	30=186.2Hz	

## Tilbehör

■ Batteripaket NI-MH 7,2V/1350 mAh (art.nr. 47308)

Bordsladdare (art.nr. 47307)

12V/600mA Adapter (art.nr. 47306)

Monofon (art.nr. 47301)

Headset (art.nr. 47302)

Se [www.zodiac.se](http://www.zodiac.se) för senaste uppdaterade tillbehörslista.

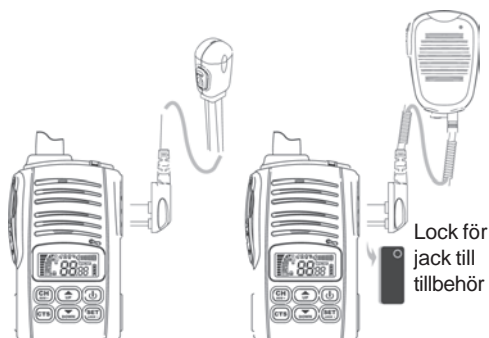

## ■ Säkerhetsanvisningar

1. Skydda radion mot fukt, vatten, köld och extrem värme.
2. Apparaten rengörs med en lätt fuktad trasa. Använd inte rengörings- eller lösningsmedel som kan skada apparaten så att garantin upphävs.
3. Utför inte reparationer/ingrepp i radion eller byte av delar. Garantin gäller inte under sådana tillfällen.
4. Sätt volymen på lägsta nivå när extra mikrofon/högtalare ansluts och justera därefter volymen.
5. Använd alltid Zodiac originaltillbehör.
6. Ta alltid ur batterierna när handenheten inte skall användas under längre tid.

**ZODIAC**



## ■ Specifikationer

Modus	FM (F3E)
Kanaler	14(446.00625-444.97500MHz)
Pilotton	38 (67.0-250.3Hz)
Frekvensstabilitet	+/- 2.5kHz
Kanalavstånd	12.5kHz
Strömförsörjning	7,2V
RX ström	<40mA (auto save off)
Audio utgångseffekt	>500mW
Känslighet (12dB sinad)	<0,22μV
Driftstemperatur	-30°C till +70°C
Vikt (inkl. batteri)	250g
Extra mikrofon jack	2.5 mm (diameter), 3-polig
Extra hörlur jack	3.5 mm (diameter), 2-polig

## ■ Garanti

Zodiac Sverige AB ger garanti i 12 månader mot fabriktionsfel. Utöver detta tillkommer konsumentköplagens bestämmelse om reklamationsrätt. Vid reklamation- eller garantihändelser måste dokumentation om köpdatum kunna visas i form av kvitto eller liknande. Vid näringsköp gäller särskilda regler.

Inom garantitiden reparerar Zodiac Sverige AB alla fel som fanns vid köpetillfället, förutsatt att apparaten är inlämnad hos den återförsäljare den är köpt hos, eller till Zodiac's serviceverkstad. Eventuell frakt betalas av köparen. Apparaten måste alltid förpackas ordentligt eller i orginalförpackning för att skydda apparaten vid sändning.

Skador som uppkommit pga handavandefel som strider mot denna bruksanvisning, slitage, överspänning, slag, fuktskada, blixtnedslag eller ingrepp av oauktoreriserade personer, faller inte under några omständigheter in under garantin och repareras efter överenskommelse med köparen mot betalning.

**ZODIAC**





## **Bruerveiledning NOR**

**ZODIAC**



## ■ Innledning

Gratulerer med ditt valg av Zodiac Freetalk Pro som din nye kommunikasjonsradio.

Zodiac Freetalk Pro er et PMR-utstyr (Private Mobile Radio) som gir deg mulighet til å snakke med så mange mennesker du vil, så ofte du vil, uten konsesjon eller samtaleavgifter. Zodiac Freetalk Pro er veldig enkel å bruke, selv for barn.

Det anbefales at brukerveiledningen leses nøye før radioen tas i bruk slik at du får nødvendig kunnskap om de ulike funksjonene.

Brukerveiledningen finnes også på vår hjemmeside [www.zodiac.no](http://www.zodiac.no).

## ■ Egenskaper

- Bruk av TCXO resonator øker frekvensstabiliteten
- Digitalt utviklet sikrer stabil kvalitet
- Ekstra lite håndsett i solid materiale som tilfredstiller US Military Standards 810E
- 7 anropstøner og MORSE-kode
- 8 VOX-nivåer med hurtig inn-/utkobling av VOX
- 3-trinns Auto-power sparemodus/4-trinns Auto-power OFF/4-trinns Time-out-timer
- Både kanal- og frekvenssøkefunksjon
- 1 nødkanal og 1 minnekanal
- 14 kanaler med 38 pilottonkoder (CTCSS) for hver kanal
- Bakgrunnsbelyst display

## **Innhold**

<b>Beskrivelse av radioen</b>	<b>side 4</b>
<b>Beskrivelse av displayet</b>	<b>side 5</b>
<b>Virkemåte</b>	<b>side 6</b>
Power ON/OFF	side 6
Sending/mottaking	side 6
Justering av volumet	side 6
Valg av kanal	side 6
Kanalsøking	side 7
Pilottonesystem ON/OFF (CTCSS)	side 7
Bakgrunnslys	side 8
Monitor	side 8
Tastelås	side 8
Valg av funksjoner	side 9
Anropstøner	side 9
Strømsparemodus	side 9
VOX (stemmestyring)	side 10
VOX følsomhet	side 10
TX/RX (Forskjellige kanaler)	side 10
Tastetøner	side 11
Auto-power	side 11
Time-Out Timér	side 11
Squelch	side 12
Repeater	side 12
Anropstone	side 12
VOX ON/OFF	side 12
Minnekanal	side 13
Nødkanal	side 13
2-kanalvakt	side 14
Valg av minnekanal og nødkanal	side 14
Gjenopprette fabrikkinnstillinger	side 15
<b>Innsetting/fjerning av batteripakke</b>	<b>side 15</b>
<b>Ladning av batteri</b>	<b>side 16</b>
<b>Frekvenstabell kanaler</b>	<b>side 17</b>
<b>Pilottonetabell</b>	<b>side 17</b>
<b>Tilbehør</b>	<b>side 18</b>
<b>Sikkerhetsanvisninger</b>	<b>side 18</b>
<b>Tekniske data</b>	<b>side 19</b>
<b>Garanti</b>	<b>side 19</b>

## ■ Beskrivelse av radioen

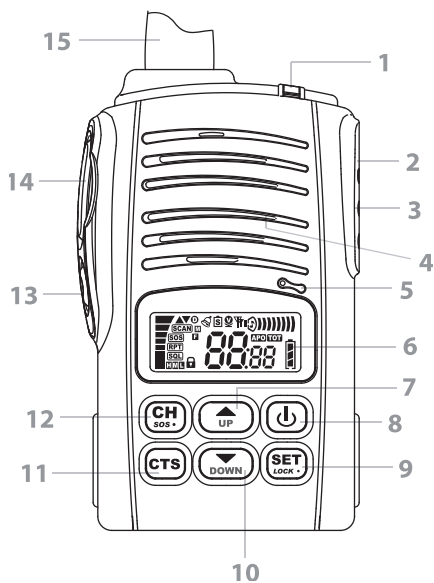







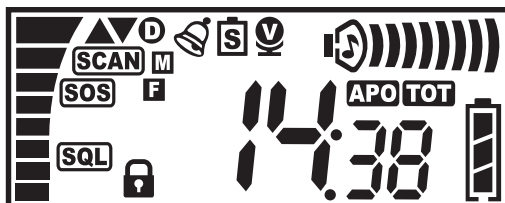









- |                           |                                       |
|---------------------------|---------------------------------------|
| 1. LED lampe              | 9. Funksjonstast                      |
| 2. Ekstern høyttaler jack | 10. DOWN-tast (ned)                   |
| 3. Ekstern mikrofon jack  | 11. Pilottone-tast (CTCSS)            |
| 4. Høyttaler              | 12. Kanaltast                         |
| 5. Mikrofon               | 13. Tast for bakgrunnslys/<br>monitor |
| 6. LCD Display            | 14. PTT-tast (Push-To-Talk)           |
| 7. UP-tast (opp)          | 15. Antenne                           |
| 8. Power-tast             |                                       |

# ZODIAC



## ■ Beskrivelse av displayet



-  Anropstone
-  Auto-Power sparemodus
-  VOX (talestyring)
-  Tastetone
-  Volum
-  Auto-Power-Off
-  TX Time-Out-Timér
-  Batteristatus
-  Pilottonekode (CTCSS code)
-  Kanalnummer
-  Squelch nivå (støysperrenivå)
-  Tastelås
  
-  Nødkanal
-  Minnekanal
-  Kanalsøking (scanning)
-  Signalstyrkeindikator
  
-  2-kanalvakt



## ■ Virkemåte

### 1. Power ON/OFF

Trykk  for å slå på håndsettet. For å slå av, trykk og hold  nede i ca. 2 sekunder.

### 2. Sending/Mottaking







Trykk og hold inne , og snakk med normal stemme i mikrofonen. LED lampe lyser rødt under sending. Slipp  for å motta. LED lampe lyser grønt under mottaking.

※ Hold håndsettet med mikrofonen ca. 10 cm fra munnen mens du snakker med normal stemme.

### 3. Justering av volumet



Trykk  for å øke volumet. Trykk  for å minske volumet. Trykk og hold  eller  for hurtig volumjustering.

※NB! Ved bruk av eksternt mikrofon eller høretelefon, start fra laveste volum ved justering av volumet.

### 4. Valg av kanal





Trykk **CH**. Mens kanalindikatoren blinker i displayet, trykk **UP** eller **DOWN** for å velge ønsket kanal. For å forhåndsinnstille kanalen, trykk kort på **CH** eller **SET**.

## 5. Kanalsøking (scanning)



Trykk **CH**. Mens kanalindikatoren blinker, trykk og hold **UP** eller **DOWN** i 2 sekunder for å starte kanalsøkingen. Når kanalnummeret gjør et hopp, enten opp eller ned, viser dette at kanalsøkingen er aktiv. Søkingen stanser når det detekteres en opptatt kanal. Et kort trykk på **CH** eller **SET** avslutter søkingen og den siste opptatte kanalen velges.

- ※ Ved kanalsøking skal Pilottonesystemet (CTCSS) være avslått dvs. at radioen ikke søker på CTCSS toner

## 6. Pilottonesystem ON/OFF (CTCSS)





Trykk og hold **CTS** i 2 sekunder for å aktivere pilottonesystemet. Trykk og hold **CTS** på nytt i 2 sekunder for å slå av igjen pilottonen.

Når Pilottonesystemet er slått på, trykk **UP** eller

 for å velge ønsket pilottone. Lagre ønsket verdi ved å trykke på .

## 7. Bakgrunnslys

Trykk  et kort øyeblikk for å slå på bakgrunnslyset i displayet. Trykk  på nytt for å slå av igjen lyset eller det slås av automatisk etter 5 sekunder.

## 8. Monitor



Trykk og hold  i ca. 1 sekund. Du vil nå høre susing hvis kanalen er ledig eller alle signalene på kanalen høres uavhengig av pilottoneinnstillingen. LED lampe lyser grønt.

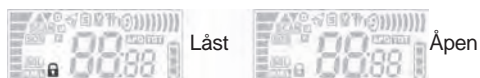

※ Monitor brukes for

- å motta svake signaler pga. avstanden eller for å motta periodiske signaler
- å motta alle signaler på en kanal selv med forskjellige pilottoner.

## 9. Tastelås



Trykk og hold  i ca. 3 sekunder til  vises i displayet som bekreftelse på at tastelåsen er innkoblet.

For å koble ut tastelåsen, trykk og hold  på nytt i 3 sekunder inntil  forsvinner.

※ Når tastelåsen er innkoblet, vil volumkontroll og funksjonsvalg være sperret for å forhindre uønskede endringer.

## 10. Valg av funksjoner



Trykk **SET** for å starte valg av funksjoner og åpne menymodus i displayet. Bruk **UP** og **DOWN** for å bla i de forskjellige menyene for funksjonsvalgene 1 - 10.

### **F1** Anropstoner

Under funksjonsvalg 1 kan du velge mellom 7 ulike anropstoner (1 - 7).

Fabrikkinnstilling: 1



### **F2** Strømsparemodus

Under funksjonsvalg 2 kan du velge mellom ulike strømspareinnstillinger. Velg 1-4 for minst mulig strømførbruk hvis du for det meste har mye korte samtaler.

Fabrikkinnstilling: OFF



**F3 Stemmestyring (VOX)**

Under funksjonsvalg 3 kan du velge om VOX-funksjonen skal være innkoblet eller utkoblet.

Fabrikkinnstilling: OFF

**F4 VOX følsomhet**

Under funksjonsvalg 4 kan du velge mellom 9 følsomhetsnivåer for VOX. Nivå L9 gir lavest følsomhet. Se også pkt. 12.

NB! Denne funksjonen blir automatisk fjernet hvis VOX er utkoblet under **F3**.

**F5 TX/RX forskjellige kanaler**

Denne funksjonen er ikke i bruk i Norge.

**F6 Tastetoner**

Under funksjonsvalg 6 kan du velge om tasteklikk skal være innkoblet eller utkoblet. Tastetoner gir en tone hver gang en tast trykkes ned. Kun svak tone ved OFF

Fabrikkinnstilling: ON

**ZODIAC**

**F7 Auto-power**

Under funksjonsvalg 7 kan du velge mellom OFF/03/10/30/60 min. for Auto-power. Hvis 03 velges, vil radioen bli slått av automatisk hvis ingen taster er trykket eller intet signal er mottatt i løpet av 3 minutter.

Fabrikkinnstilling: OFF

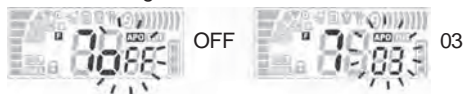
**F8 Time-Out Timér**

Under funksjonsvalg 8 kan du velge mellom OFF/30/60/120/180 sekunder for Time-Out Timéren. Hvis 30 velges, vil radioen stoppe sendingen ved kontinuerlig tale i mer enn 30 sekunder og automatisk skifte til mottaking.

Fabrikkinnstilling: OFF

**F9 Squelch**

Under funksjonsvalg 9 kan du velge mellom 7 nivåer for squelch. Nivå 0 gir høyest følsomhet og medfører konstant susing. Nivå 1 er best ved svake signaler, men er samtidig følsom for interferens. Nivå 7 gir

minst følsomhet og er best egnet for bruk ved mye interferens.

Fabrikkinnstilling: 3



### **F10** Repeater

Denne funksjonen er ikke i bruk i Norge.

## 11. Anropstone



Under sending ( **PTT** holdes inne), trykk **CTS** for å sende en anropstone til mottakere.

For valg av anropstone, se **F1**.

## 12. VOX ON/OFF



Under sending ( **PTT** holdes inne), trykk **SET LOCK** for å koble inn VOX (stemmestyringsfunksjon).

For utkobling av VOX, hold **PTT** og trykk **SET LOCK** på nytt.

For valg av følsomhet for VOX, se **F4**.

- ※ Når VOX er innkoblet, er det ikke lenger nødvendig å trykke **PTT** under sending. Bare snakk i mikrofonen med passende styrke (avhengig av valgt følsomhet).

### 13. Minnekanal



1. Hold **CH** og trykk **DOWN** for å velge minnekanal. Minnekanalen er merket med **M**. (Se pkt. 17 for forhåndsinnstilling av minnekanalen.)
2. Hold **CH** og trykk **UP** for å gå tilbake til den tidligere valgte kanalen.

Fabrikkinnstilling: CH01 og CTCSS OFF

### 14. Nødkanal









For å koble inn nødkanalen, hold **CH** inne i ca. 3 sekunder inntil **SOS** vises i displayet.

For å koble ut nødkanalen igjen, hold **CH** inne i ca. 3 sekunder inntil **SOS** forsvinner fra displayet.

### 15. 2-kanalvakt











Trykk og hold  til kanalindikatoren blinker. Hold  og  inne samtidig i ca. 1 sekund og slipp dem deretter for å koble inn funksjonen. Forhåndsvalgt kanal og minnekanal blinker vekselvis i displayet. Når et signal mottas på disse kanalene, vises kanalnummeret i displayet. Denne kanalen er låst i ca. 8 sekunder for å svare. Hvis intet signal blir mottatt etter 8 sekunder, starter kanalvekslingen igjen. For å velge en kanal å bruke under kanalvekslingen, trykk  når ønsket kanal vises. Denne kanalen vil være i standby stilling i ca. 8 sekunder før kanalvekslingen starter igjen. For å unngå dette, trykk samtidig  og .

## 16. Valg av minnekanal og nødkanal

1. Velg ønsket kanal og pilotone (CTCSS).



2. Trykk og hold  og  samtidig. Mens  fortsatt holdes, slippes  og trykk deretter  eller  inntil  eller  vises i displayet.

 viser minnekanalen og  nødkanalen.

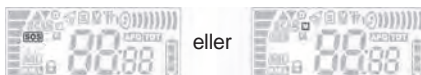

eller



3. Når ønsket kanal vises, trykk **SET LOCK** for å velge denne.
4. Etter lagring, slipp **CH** for å gå ut av programmeringsmodus.

## 17. Gjenopprette fabrikkinnstillinger

1. Slå av radioen (power OFF).
2. Trykk og hold **SET LOCK** og samtidig slå på radioen (power ON).

## ■ Innsetting/fjerning av batteripakke

### Innsetting av batteri

1. Legg batteripakken i batterirommet som vist på tegning #1.
2. Skyv batteriet oppover som vist på tegning #2. Batteriet vil bli låst på plass.

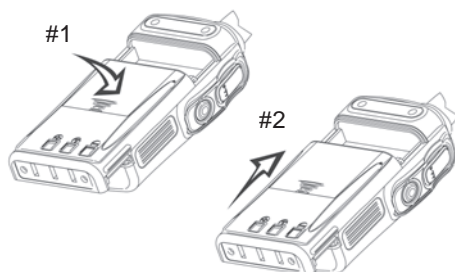

### Fjerning av batteri

1. Hold radioen med den ene hånden og skyv låsehendelen til batterirommet som vist på tegning #3.
2. Skyv batteriet nedover som vist på tegning #4.

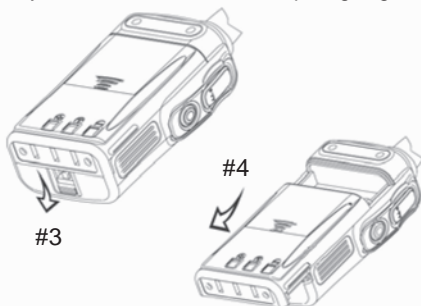

### Ladning av batteri

1. Plugg laderens strømforsyning i en 230V veggkontakt, se tegning #1.
2. Sett radioen med batteri i laderens ladeplass #2.
3. Sett ekstra batteripakke i laderens ladeplass #3.

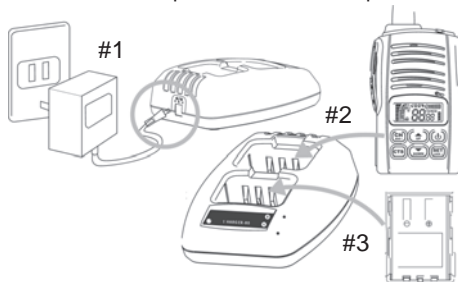

**ZODIAC**

Laderen har to ladeplasser og kan samtidig lade en radio med innsatt batteri og et ekstra batteri. Både enkel eller dobbel ladning er mulig. Hver ladeplass har egen LED lampe som viser ladestatus. LED lampen slukker når batteriet er fulloppladet.

### Frekvenstabell kanaler

Kanal	Frekvens (MHz)	Kanal	Frekvens (MHz)
1	446.00625	8	446.09375
2	446.01875	9	444.60000
3	446.03125	10	444.65000
4	446.04375	11	444.80000
5	446.05625	12	444.82500
6	446.06875	13	444.85000
7	446.08125	14	444.97500

### Pilottonetabell (CTCSS)

01=67.0Hz	11= 97.4Hz	21=136.5Hz	31=192.8Hz
02=71.9Hz	12=100.0Hz	22=141.3Hz	32=203.5Hz
03=74.4Hz	13=103.5Hz	23=146.2Hz	33=210.7Hz
04=77.0Hz	14=107.2Hz	24=151.4Hz	34=218.1Hz
05=79.7Hz	15=110.9Hz	25=156.7Hz	35=225.7Hz
06=82.5Hz	16=114.8Hz	26=162.2Hz	36=233.6Hz
07=85.4Hz	17=118.8Hz	27=167.9Hz	37=241.8Hz
08=88.5Hz	18=123.0Hz	28=173.8Hz	38=250.3Hz
09=91.5Hz	19=127.3Hz	29=179.9Hz	
10=94.8Hz	20=131.8Hz	30=186.2Hz	

## Tilbehør

Batteripakke NI-MH 7,2V/1350 mAh (art.nr. 47308)

Hurtiglader/bordlader (art.nr. 47307)

12V/600mA Adapter ADA (art.nr. 47306)

Ekstern høyttaler/mikrofon (art.nr. 47301)

Ekstern øretelefon/mikrofon (art.nr. 47302)

Se [www.zodiac.no](http://www.zodiac.no) for oppdatert tilbehørsliste.

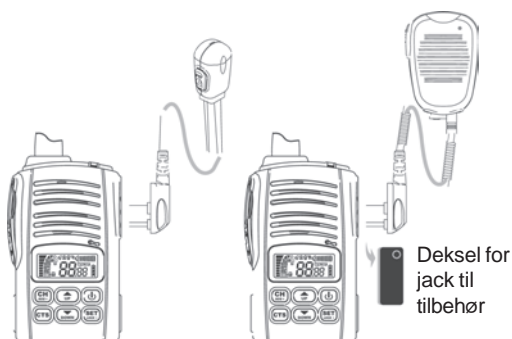

## Sikkerhetsanvisninger

1. Beskytt radioen mot fuktighet, vann, kulde og ekstrem varme.
2. Radioen rengjøres med en lett fuktet klut. Bruk ikke rengjørings- eller løsningsmidler som kan skade radioen slik at garantien oppheves.
3. Ikke foreta reparasjoner/inngrep i radioen eller utskifting av deler. Garantien vil i slike tilfeller bortfalle.
4. Sett volumet på laveste nivå ved tilkobling av ekstern mikrofon/høyttaler og etterjuster volumet.
5. Bruk kun original lader
6. Ta alltid ut batteriet når radioen ikke skal brukes på en lengre stund.

**ZODIAC**

## ■ Tekniske data

Modus	FM (F3E)
Antall kanaler	14 (446.00625-444.97500MHz)
Antall pilottoner	38 (67.0-250.3Hz)
Frekvensstabilitet	+/- 2.5kHz
Kanalavstand	12.5kHz
Strømforsyning	7,2V
RX strøm	<40mA (auto save off)
Audio utgangseffekt	>500mW
Følsomhet (12dB sinad)	<0,22µV
Driftstemperaturområde	-30°C til +70°C
Vekt (inkl. batteri)	250g
Ekstern mikrofon jack	2.5 mm (diameter), 3-leder
Ekstern SP jack	3.5 mm (diameter), 2-leder

## ■ Garanti

Zodiac Norge AS gir garanti i 12 måneder mot fabrikkasjonsfeil. Utover dette kommer kjøpslovens bestemmelser om reklamasjonsrett. Ved reklamasjon- eller garantihenvendelser må dokumentasjon på kjøpsdato fremlegges i form av kjøpskvittering eller lignende. Ved næringskjøp gjelder særskilte regler.

Innenfor garantitiden reparerer Zodiac Norge AS alle feil som var iboende i apparatet i kjøpsøyeblikket, forutsatt at apparatet innleveres hos den forhandleren hvor det ble kjøpt, eller til Zodiac's serviceverksted. Eventuell frakt betales av kjøperen. Apparatet må alltid pakkes forsvarlig eller i originalemballasjen ved forsendelsen.

Skader som skyldes feil bruk i henhold til bruksanvisningen, slitasje, overspenning, slag, fuktskade, lynnedslag eller inngrep av uautoriserte personer, faller ikke under noen omstendigheter inn under garantien og vil bli reparert etter ordre fra kjøper mot betaling.

# ZODIAC





PK AL02-1 VER.5



The logo for ZODIAC, featuring the word "ZODIAC" in a bold, serif font. The letter "Z" is significantly larger and more stylized than the other letters. A horizontal line is positioned directly beneath the letters "O", "D", and "I".

**ZODIAC**

[www.zodiac.se](http://www.zodiac.se)  
[www.zodiac.no](http://www.zodiac.no)